

AVATAR POP

designed by
FERNANDO MARTÍNEZ



WATCH VIDEO

AVATAR POP

Este diseño nace de la idea de iluminar espacios amplios con líneas de luz suspendidas en diferentes puntos. AVATAR POP se presenta, no solo como un colgante individual, sino también siguiendo la fórmula KIT que caracteriza a otras colecciones, permitiendo crear conjuntos de hasta 4 perfiles de gran potencia lumínica y combinar los diferentes tamaños de perfiles existentes. Cada colgante posee un sistema manual de orientación de hasta 105°.

AVATAR POP

This design is born from the idea of lighting a wide space, with lines of light suspended in different points. AVATAR POP is presented, not only as an individual pendant, but also following the KIT formula that characterizes other collections, allowing the creation of sets up to 4 profiles of high luminous power and combine the different sizes of the existing profiles. Each pendant has a manual orientation system of 105°.

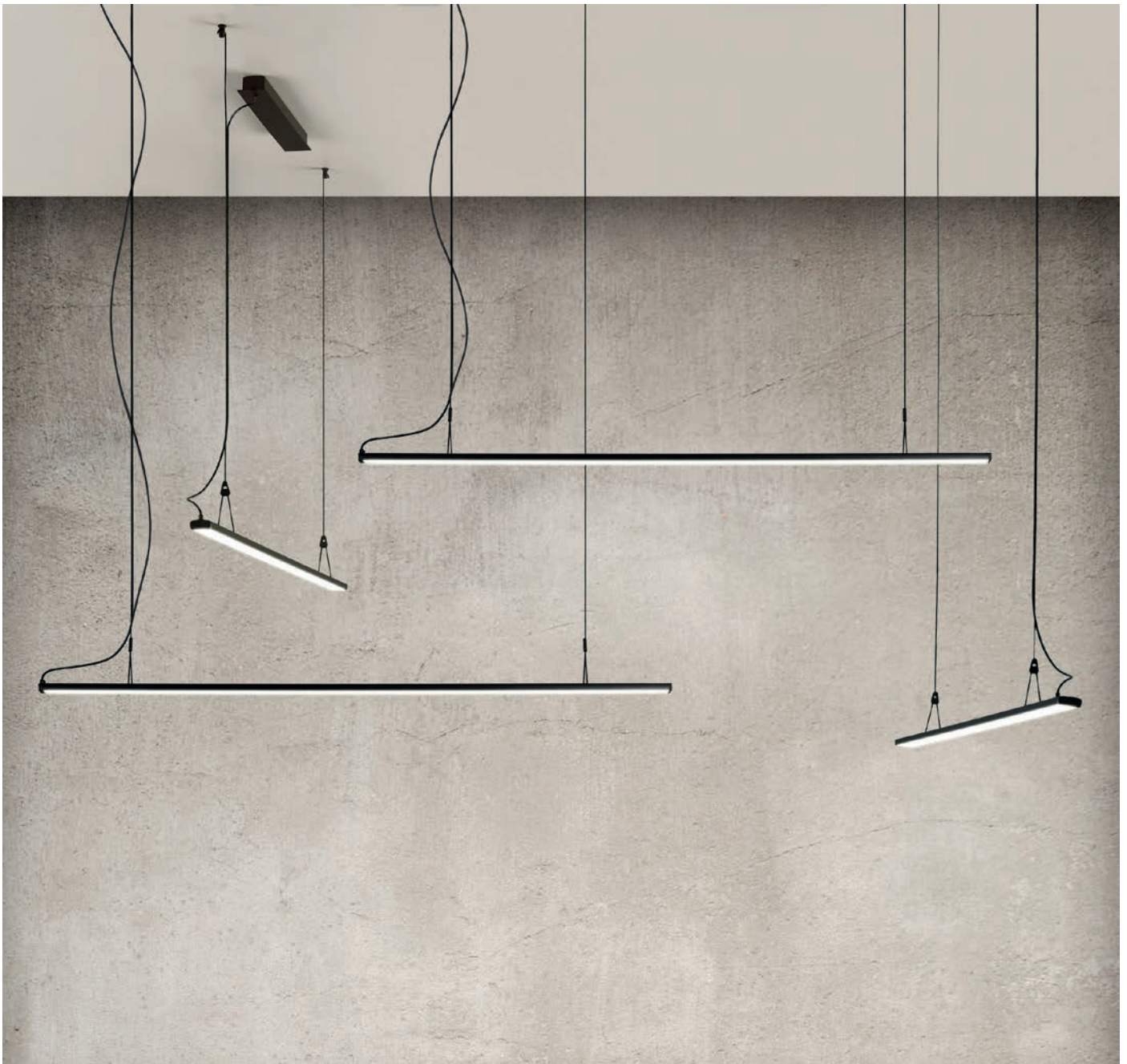

AVATAR POP colgantes / AVATAR POP suspensions

AVATAR POP está compuesto por perfiles de diferentes medidas (125cm - 200cm - 300cm) hasta un máximo de un conjunto total de 9 metros (155W) de perfiles por luminaria + el KIT de instalación apropiado a su potencia. Según los metros que sumen el total de los perfiles, se necesita un KIT con un driver diferente. Los KITS tienen un máximo de 4 salidas. Si se desean más salidas consultar con fábrica.

AVATAR POP is composed of profiles of different sizes (125cm - 200cm - 300cm) up to a maximum of a set of 9 meters (155W) of profiles in total per luminaire + the installation KIT appropriate to its power. Depending on the meters of total profiles, it is needed a KIT with a different driver. The KITS have a maximum of 4 outputs. If more outputs are needed, ask factory.

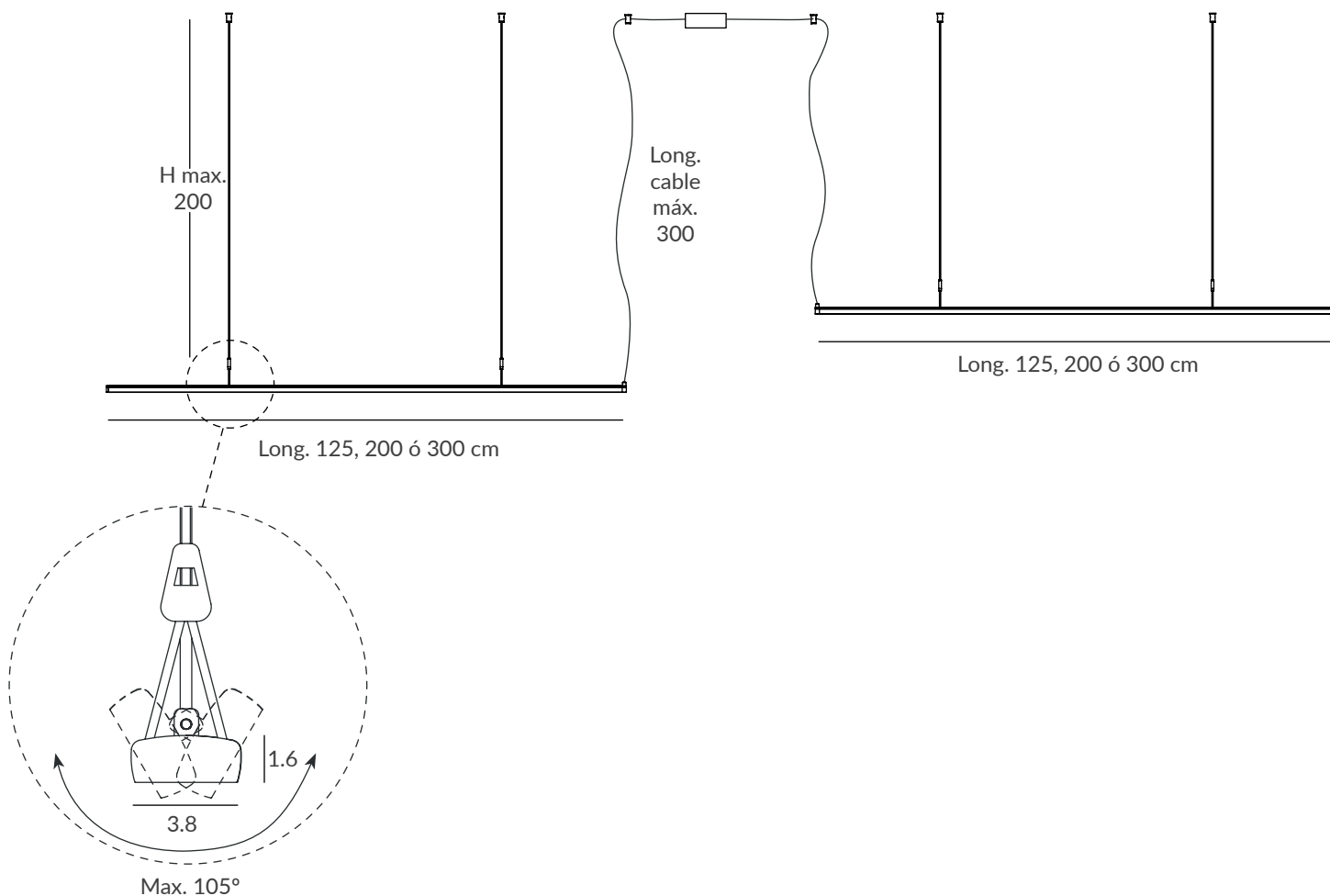

Base KIT 1 (para perfil individual)
Base KIT 1 (for single profile)

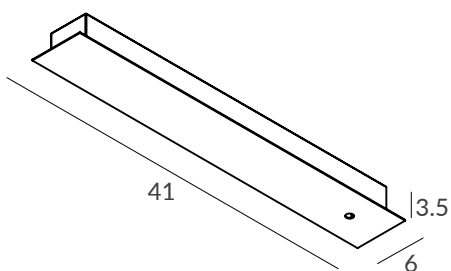

Base KITS 2, 3 y 4 (para múltiples perfiles)
Base KIT 2, 3 and 4 (for multiple profiles)

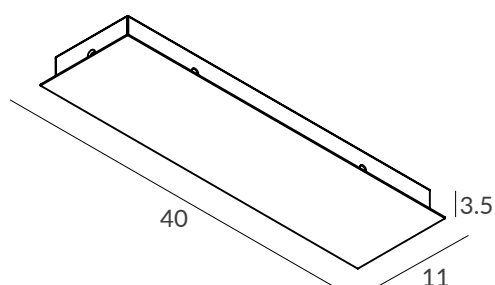

NOTA: En caso de necesitar más perfiles, añadir un florón más / NOTE: In case you need more profiles, add one more canopy.

AVATAR POP colgantes / AVATAR POP suspensions

Perfiles / Profiles

REF.
30021/125

COLGANTE / SUSPENSION
IP20

MATERIAL

Aluminio/ Aluminium

Difusor policarbonato: Blanco óptico

Polycarbonate diffuser: Optical white

ACABADO / FINISH

Negro mate/ Matt black

INSTALACIÓN / INSTALLATION

PCB-LED 125cm (21,5W) 700mA

CRI > 90

- 2700K 1541lm

- 3000K 1605lm

- 4000K 1680lm

REF.
30021/200

COLGANTE / SUSPENSION
IP20

MATERIAL

Aluminio/ Aluminium

Difusor policarbonato: Blanco óptico

Polycarbonate diffuser: Optical white

ACABADO / FINISH

Negro mate/ Matt black

INSTALACIÓN / INSTALLATION

PCB-LED 200cm (34,4W) 700mA

CRI > 90

- 2700K 2466lm

- 3000K 2568lm

- 4000K 2688lm

REF.
30021/300

COLGANTE / SUSPENSION
IP20

MATERIAL

Aluminio/ Aluminium

Difusor policarbonato: Blanco óptico

Polycarbonate diffuser: Optical white

ACABADO / FINISH

Negro mate/ Matt black

INSTALACIÓN / INSTALLATION

PCB-LED 300cm (51,6W) 700mA

CRI > 90

- 2700K 3699lm

- 3000K 3852lm

- 4000K 4032lm

Ref. 30021/125 (21,5W)

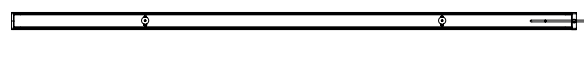

Long. 125 cm

Ref. 30021/200 (34,4W)

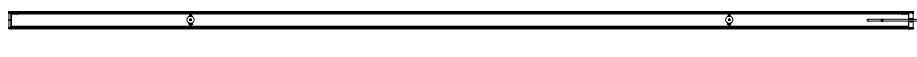

Long. 200 cm

Ref. 30021/300 (51,6W)

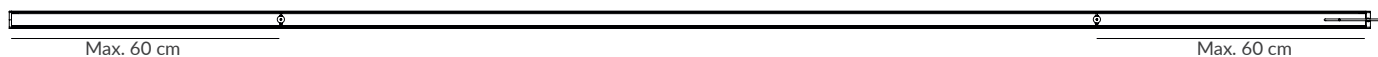

Long. 300 cm

KIT (florón + driver) / KIT (canopy + driver)

Máximo de 4 salidas por KIT / Max. of 4 outputs per KIT (canopy+ driver)

REF.
KIT 30021/1
(Para un total de 1,25m a 2m)
(For a total from 1,25m to 2m)

ACABADO / FINISH
Negro mate/ Matt black

Ⓓ dim DALI Ⓟ dim PUSH
Ⓒ dim Casambi

REF.
KIT 30021/2
(Para un total de 2,50m a 4,75m)
(For a total from 2,50m to 4,75m)

ACABADO / FINISH
Negro mate/ Matt black

Ⓓ dim DALI Ⓟ dim PUSH
Ⓒ dim Casambi

REF.
KIT 30021/3
(Para un total de 5m a 6,25m)
(For a total from 5m to 6,25m)

ACABADO / FINISH
Negro mate/ Matt black

Ⓓ dim DALI Ⓟ dim PUSH
Ⓒ dim Casambi

REF.
KIT 30021/4
(Para un total de 6,5m a 9m)*
(For a total from 6,5m -to9m)*

ACABADO / FINISH
Negro mate/ Matt black

Ⓓ dim DALI Ⓟ dim PUSH
Ⓒ dim Casambi

* No regulable de 8,75m a 9m
* Not dimmable from 8,75m to 9m

EJEMPLO DE CONFIGURACIÓN / CONFIGURATION EXAMPLE

1. Elegir longitud y cantidad de perfiles. Pueden combinarse diferentes medidas.

1. Choose length & quantity of profiles. Different sizes can be combined.

2. Seleccionar KIT correspondiente al total de metros. Si superamos los 9 metros, será necesario otro KIT.

2. Select KIT corresponding to the total number of meters. If we exceed 9 meters, another KIT will be necessary.

EJEMPLO 1 / EXAMPLE 1

REF. PERFILES PCB-LED / REF. PCB-LED PROFILES

4 x 30021/125

(Metros totales: 5 metros / Total meters: 5 meters)

REF. KIT (florón + driver) / REF. KIT (canopy+ driver)

KIT 30021/3

(Para un total de 5m a 6,25m / For a total from 5m to 6,25m)

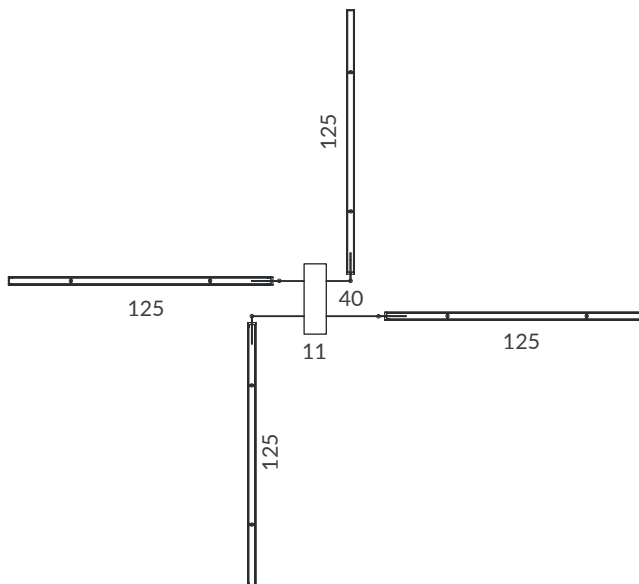

EJEMPLO 2 / EXAMPLE 2

REF. PERFILES PCB-LED / REF. PCB-LED PROFILES

1 x 30021/125

1 x 30021/200

1 x 30021/300

(Metros totales: 6,25 metros / Total meters: 6,25 meters)

REF. KIT (florón + driver) / REF. KIT (canopy+ driver)

KIT 30021/3

(Para un total de 5m a 6,25m / For a total from 5m to 6,25m)

